

Quadro de Cargas QDLT 1. Table with columns: Circ., Descrição, Luminária, Potência, Fases, Cond., Fases, Obs.

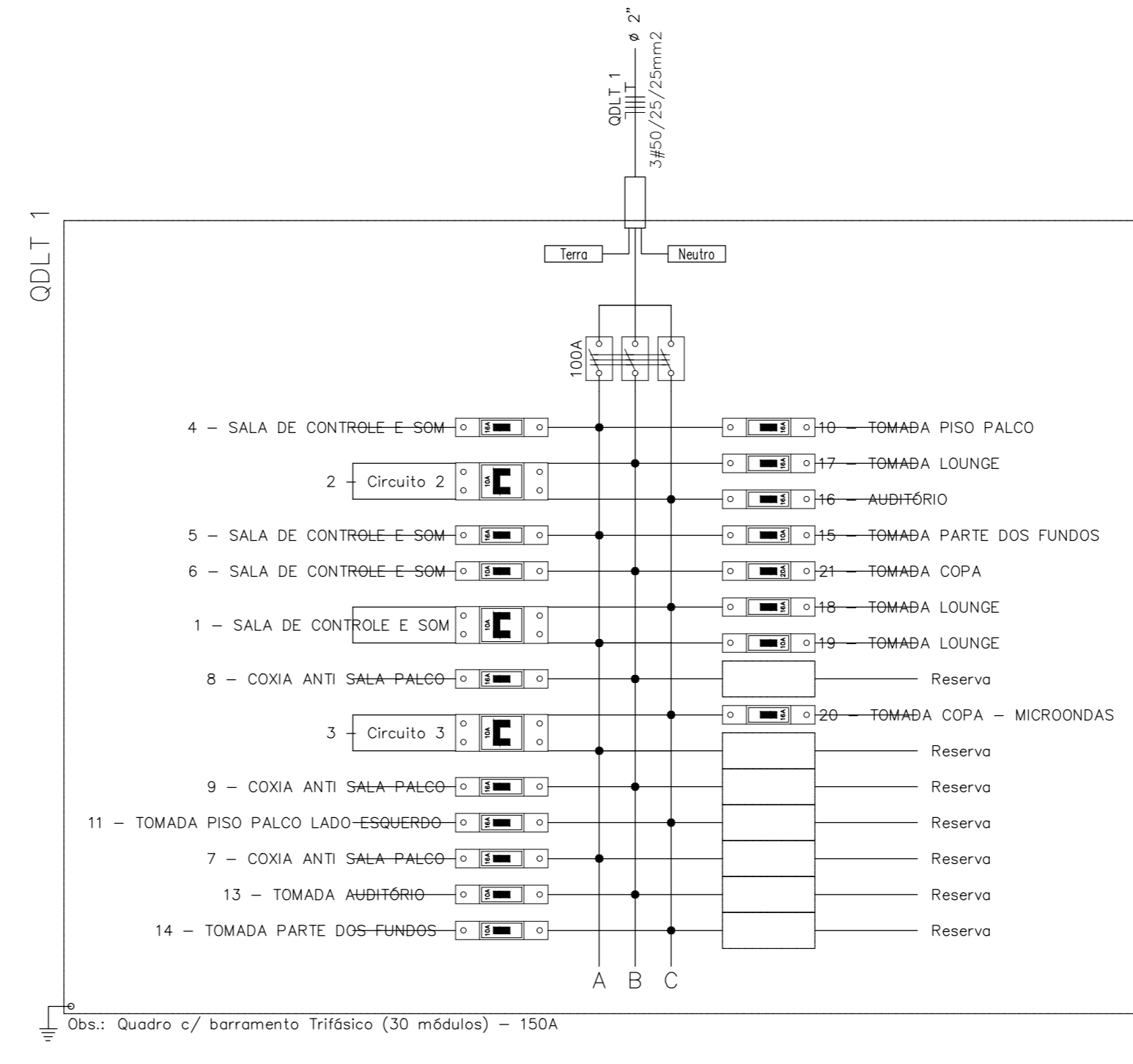
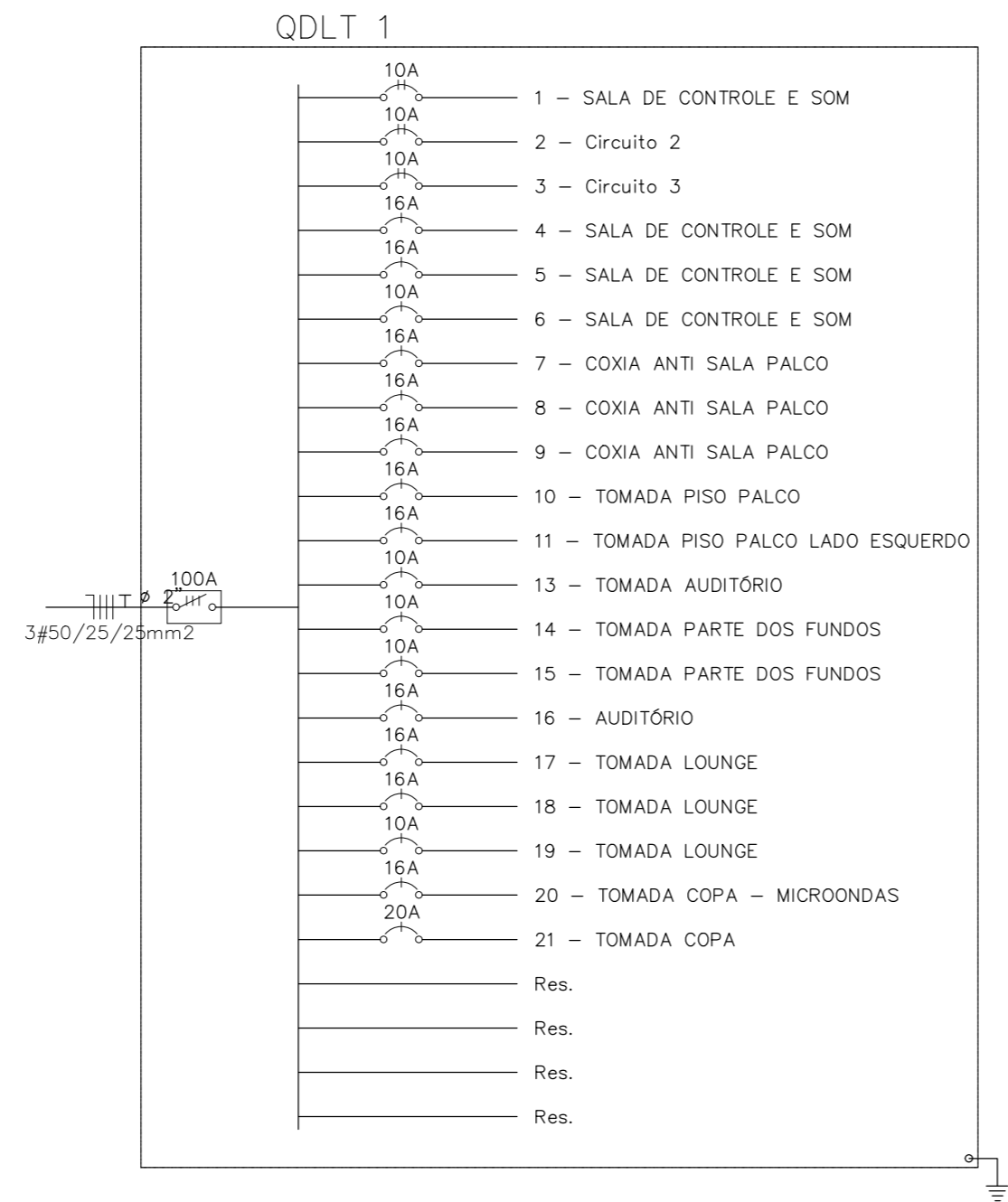

IDENTIFICAÇÃO DE QUADRO QDLT 2. Tabela com 3 colunas: CIRCUITO, UTILIDADE, LOCAL.

Table listing electrical components with columns: Num., Quant., Unid., Dimensão, Código, Descrição.

Quadro de Cargas QDAR 1. Table with columns: Circ., Descrição, Ar Cond., Pot., Fases, Cond., Fases, Obs.

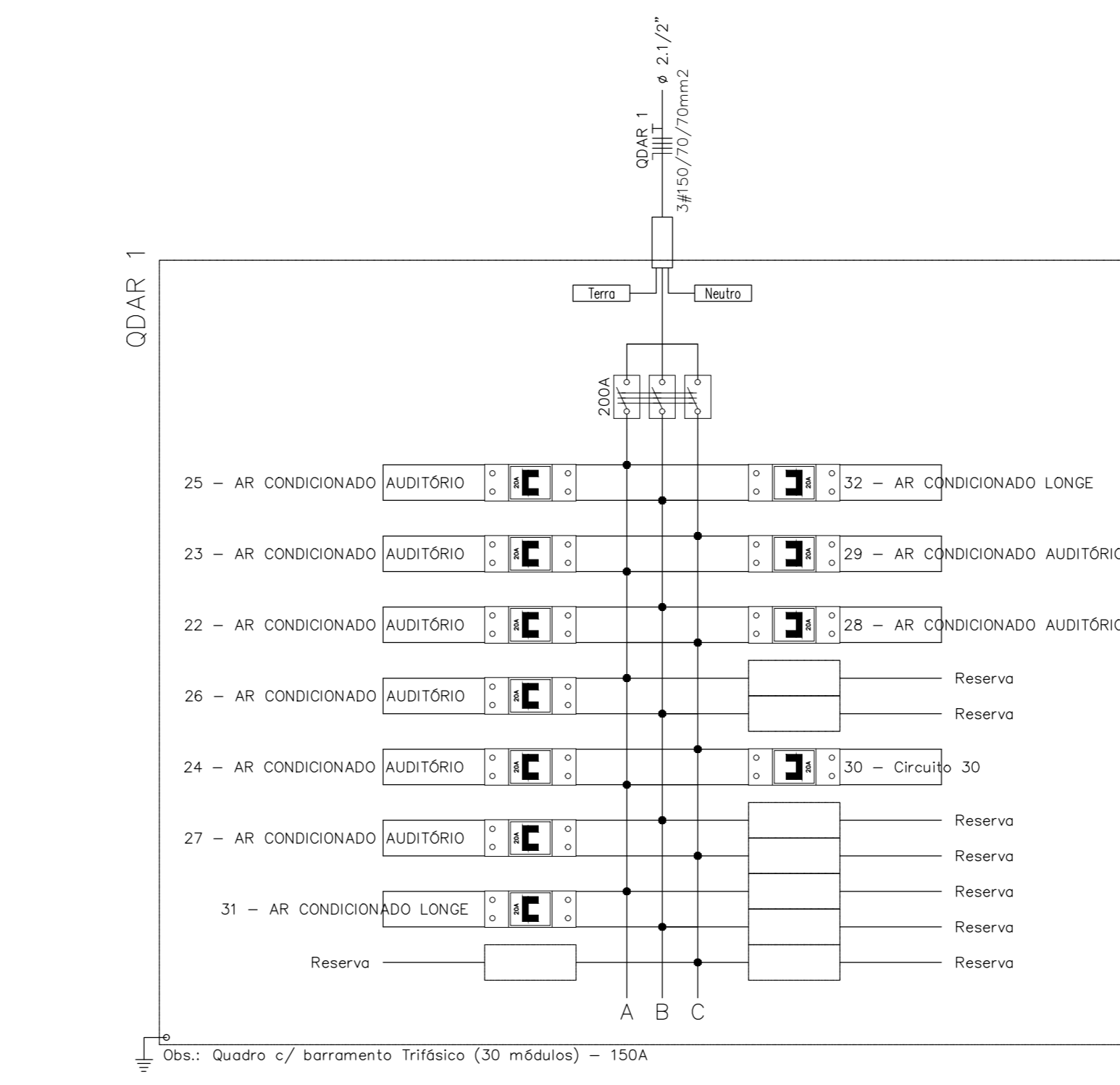
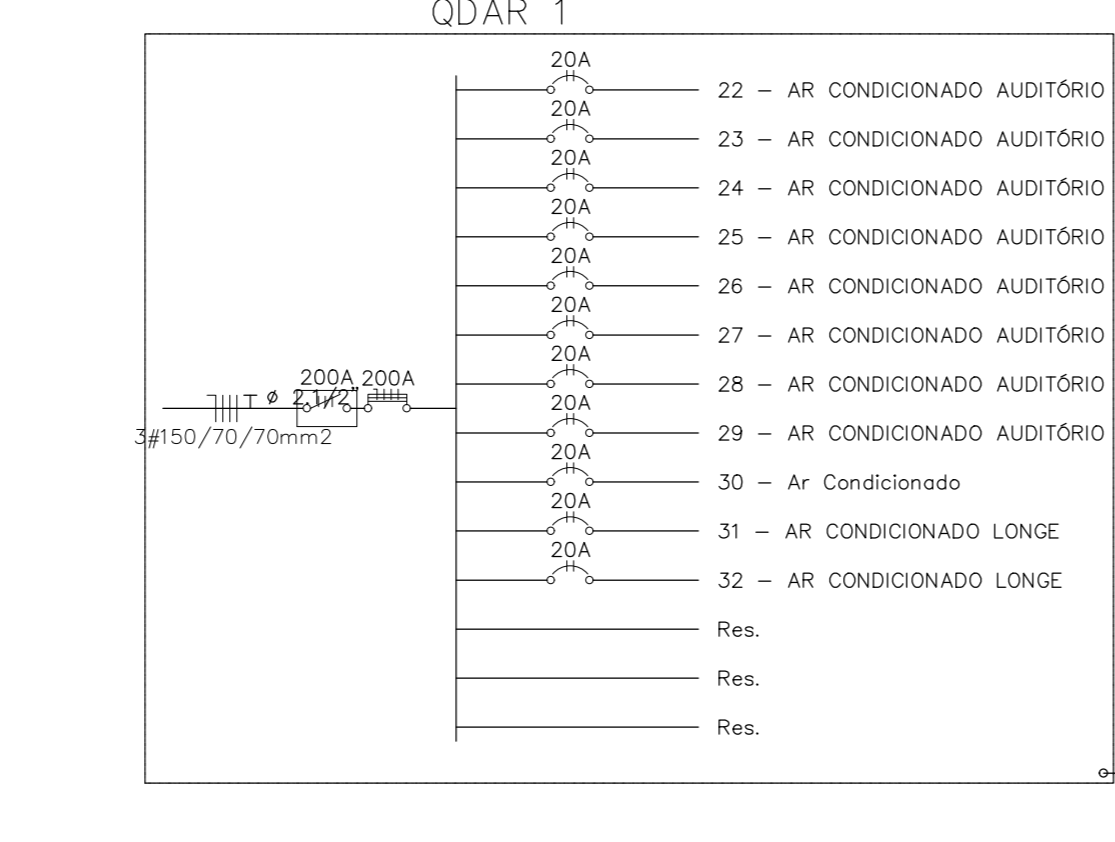

IDENTIFICAÇÃO DE QUADRO QDLT 1. Tabela com 3 colunas: CIRCUITO, UTILIDADE, LOCAL.

Table listing electrical components for various sections, including switches and lamps.

Quadro de Cargas QDLT 2. Table with columns: Circ., Descrição, Luminária, Potência, Fases, Cond., Fases, Obs.

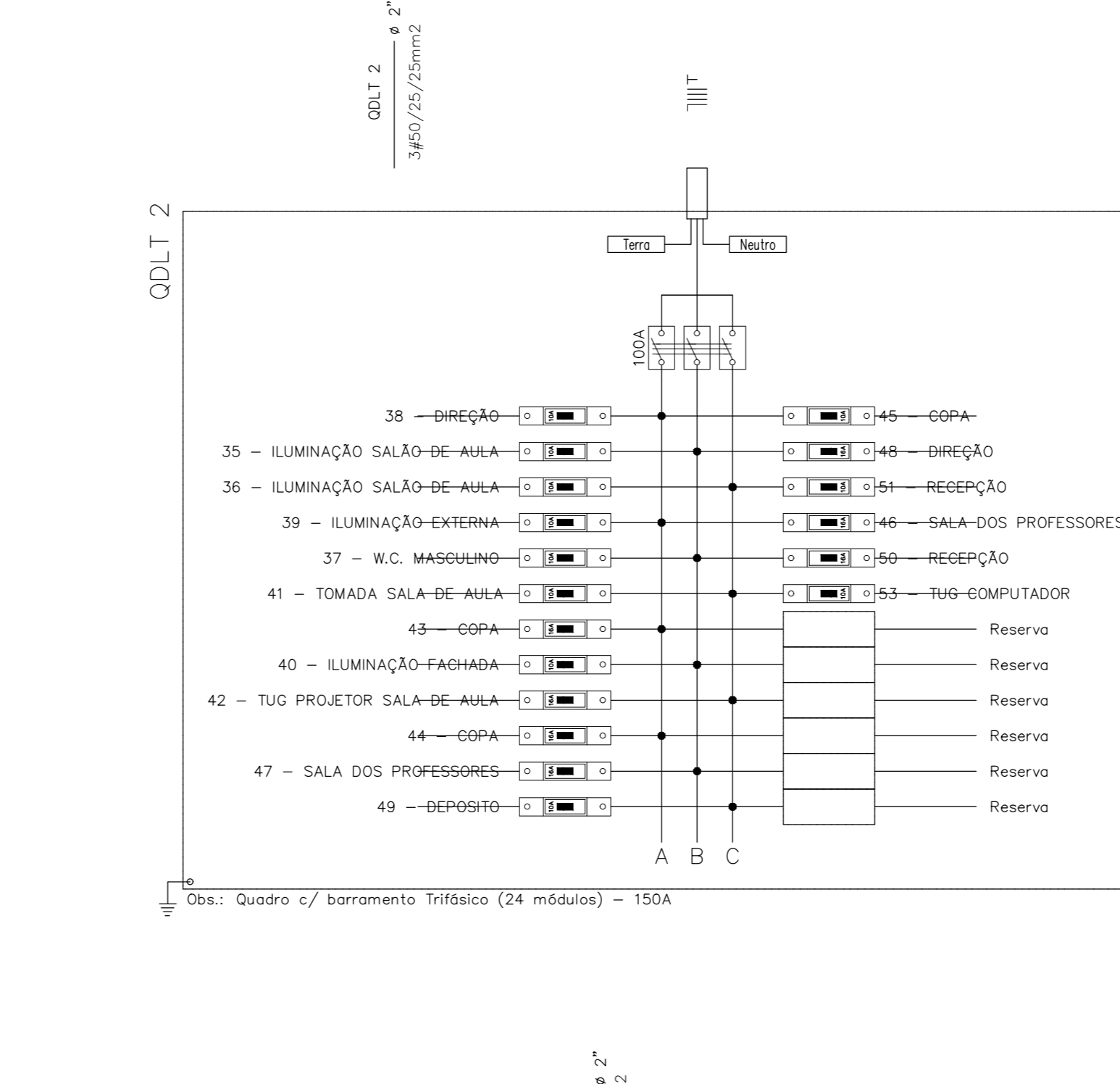
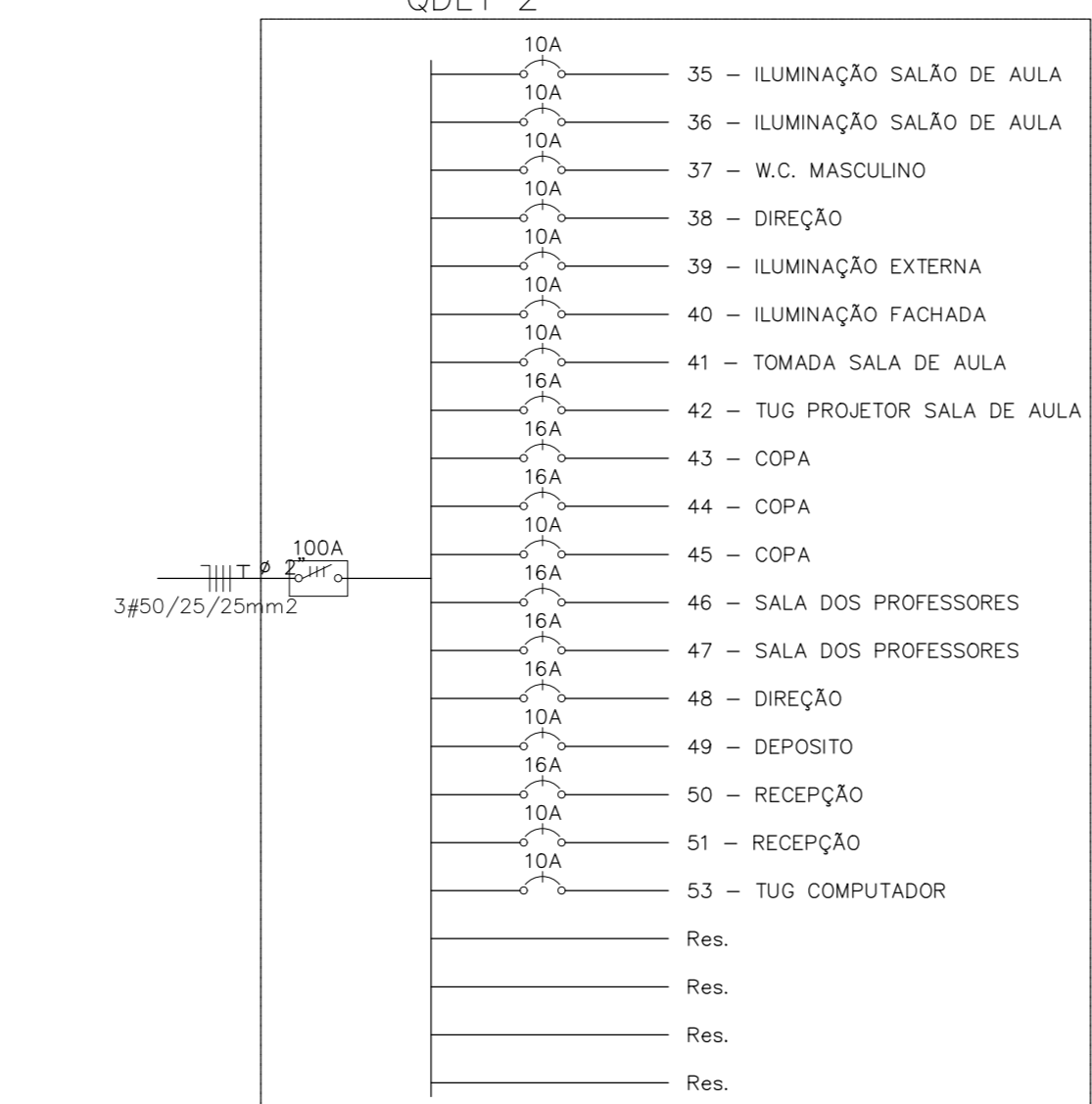

IDENTIFICAÇÃO DE QUADRO QDAR 2. Tabela com 3 colunas: CIRCUITO, UTILIDADE, LOCAL.

Table listing electrical components for air conditioning units.

Quadro de Cargas QDAR 2. Table with columns: Circ., Descrição, Ar Cond., Pot., Fases, Cond., Fases, Obs.

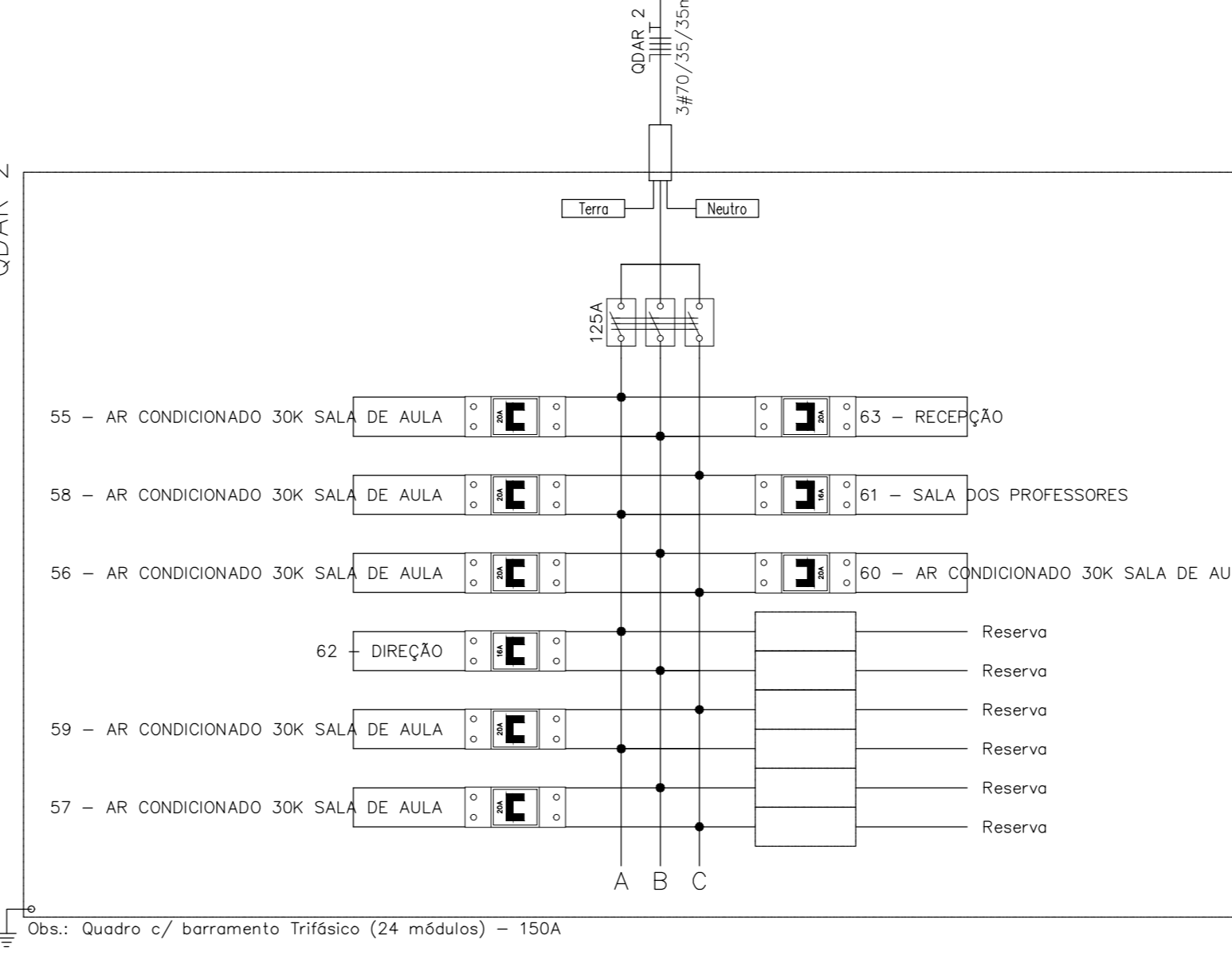
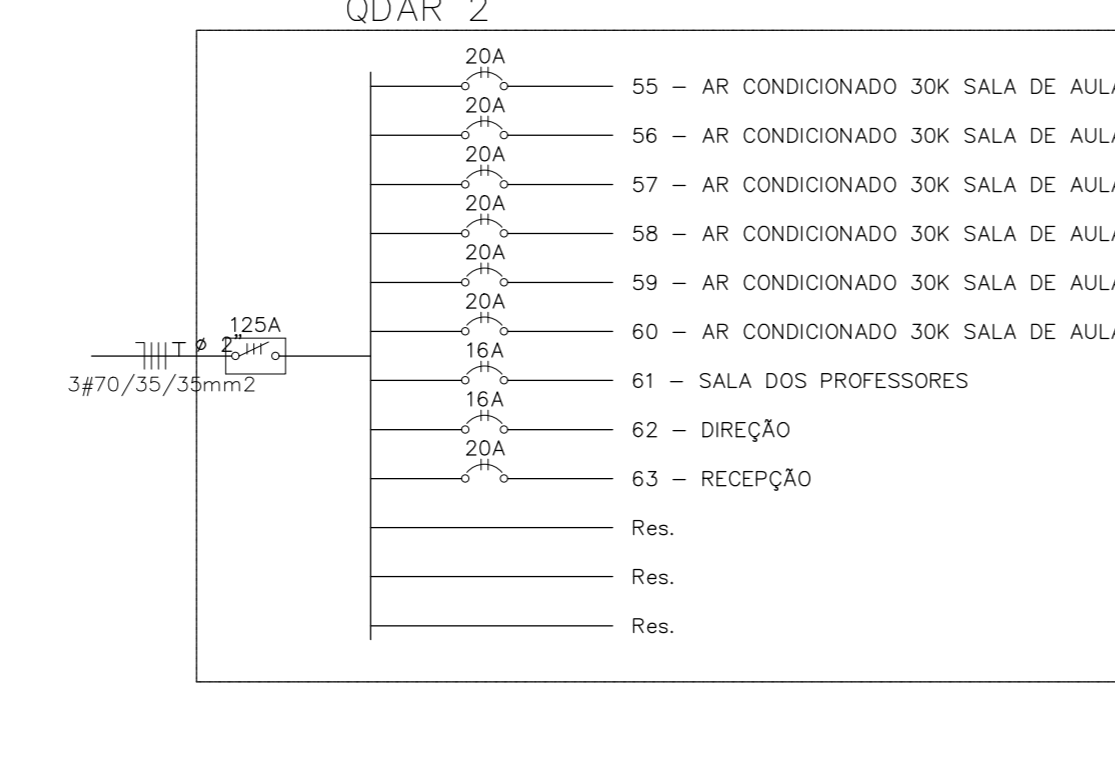

IDENTIFICAÇÃO DE QUADRO QDAR 1. Tabela com 3 colunas: CIRCUITO, UTILIDADE, LOCAL.

PREFEITURA MUNICIPAL DE IGUABA GRANDE. ESCOLA MUNICIPAL MARGARETH. 03/04. Includes contract details and dates.